

DATE: 2013-8-20 (YY/MM/DD)

Customer :

APPROVAL SHEET

PRODUCT: AC ADAPTOR(RoHS Compliant)

MODEL: APL324-1024

PART NO. ST-0222

V : A1

Receiver's stamp or signature

PLEASE APPROVE & RETURN BEFORE 2013-9-3
OR WE WOULD REGARD IT BEEN CONFIRMED.

RESPONSIBLE	APPROVED	ISSUED
		<i>nishuang</i>

ISSUES STAMP

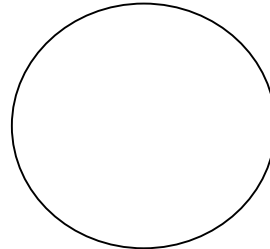

Revised History

NO.	Revised Date	Description	Approved	Issued



Anthin Power Supply Co.,Ltd. (China)

TEL:+86-755-8980-7888

FAX:+86-755-8980-1111

<http://www.Anthin.cn>

info@anthin.cn

Anthin Japan Co.,Ltd. (Japan)

TEL:+81-45-730-5250

FAX:+81-45-730-5251

<http://www.Anthin.co.jp>

info@anthin.co.jp

Anthin	DESCRIPTION	SWITCHING POWER AC ADAPTER	SHEET NO.	1 OF 4
			VER:	A1
	MODEL NO.	APL324-1024	PART NO.	ST-0222

1.INPUT REQUIREMENT

2.OUTPUT SPECIFICATION

3.MECHANICAL

4.RELIABILITY

5.ENVIRONMENT

6.OUTLOOKING

7.SAFETY

8.QC CHECK

9.DIMENSION

10.AC CORD

11.LABEL

12.PACKING

Anthin	DESCRIPTION	SWITCHING POWER AC ADAPTER	SHEET NO.	2 OF 4
	MODEL NO.	APL324-1024	VER:	A1
			PART NO.	ST-0222

1.INPUT REQUIREMENT

ITEM	SPECIFICATION	MIN	TYP.	MAX
NORMAL AC INPUT VOLTAGE	SINGLE PHASE	100Vac	110Vac/220Vac	240Vac
AC INPUT VOLTAGE RANGE	SINGLE PHASE	90Vac	110Vac/220Vac	264Vac
AC INPUT FREQUENCY	SINGLE PHASE	47Hz	50/60Hz	63Hz
AC INPUT CURRENT	TYPICAL INPUT VOLTAGE& OUTPUT AT FULL LOAD.			550mA
AC INRUSH CURRENT	TYPICAL INPUT VOLTAGE& OUTPUT AT FULL LOAD , 25°C.			30A
EFFICIENCY	TYPICAL INPUT VOLTAGE& OUTPUT AT FULL LOAD	65%		

2.OUTPUT SPECIFICATION

ITEM	SPECIFICATION	MIN	TYP.	MAX
NORMAL DC OUTPUT VOLTAGE			10Vdc	
DC OUTPUT VOLTAGE RANGE	TYPICAL OUTPUT VOLTAGE $\pm 5\%$	9.5V		10.5V
LOAD CURRENT RANGE		0A		2.4A
PEAK LOAD CURRENT	TIME<60S			2.9A
RIPPLE	TYPICAL INPUT VOLTAGE , TYPICAL LOAD CURRENT , 25°C			100mV
HOLD-UP TIME	AT TYPICAL INPUT VOLTAGE AND FULL LOAD	10mS		
TURN-ON DELAY	TYPICAL INPUT VOLTAGE AND TYPICAL LOAD			1S
OVER CURRENT PROTECTION	AUTO RECOVERY			
SHORT CIRCUIT PROTECTRON	THE ADAPTER SHALL NOT DAMAGE BY SHORT THE DC OUTPUT TO GROUND			
OVER VOLTAGE PROTECTION			11.5V	15V

*TEST MEASURES

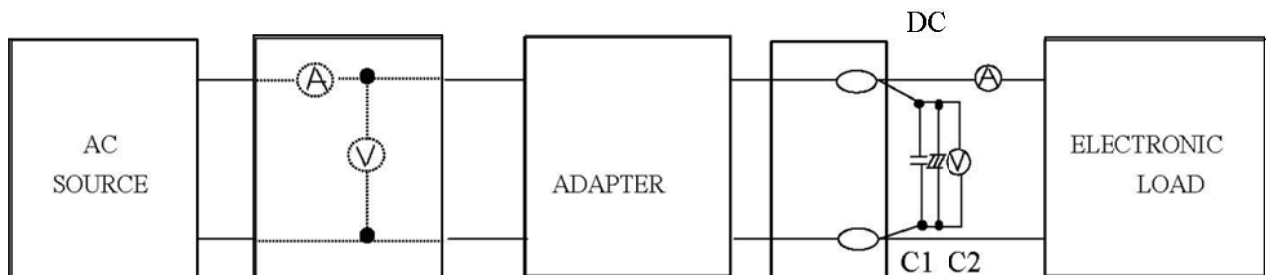

C1: 0.1uF CERAMICS CAPACITOR
C2: 10uF 50V ALUMINUM CAPACITOR

Anthin	DESCRIPTION	SWITCHING POWER AC ADAPTER	SHEET NO.	3 OF 4
	MODEL NO.	APL324-1024	VER:	A1
			PART NO.	ST-0222

3.MECHANICAL

ITEM	SPECIFICATION OR TEST CONDITION	ACCEPTANCE CRITERIA
BENDING TEST	NORMAL TEMPERATURE THE CORD SHALL WITHSTAND WEIGHT OF 200g, SWINGING FROM LEFT TO RIGHT AT AN ANGLE OF 60 DEG. 1000CYCLE TIMES MIN. S/R SHALL WITHSTAND WEIGHT OF 1N. SWINGING FROM LEFT TO RIGHT AT AN ANGLE OF 60DEG. 1000CYCLE TIMES MIN. BENDING SPEED 40CYCLE/MINUTE	NO SHORT CIRCUIT NO BREAKAGE OF THE CORD
VIBRATION	FREQUENCY RANGE:10~55Hz AMPLITUDE:1.5mm ACCELERATION: 1G SWEEP 1 MINUTE FOR X,Y,Z,AXIS EACH	THERE SHALL BENO ABNORMALITY ON THE APPEARANCE STRUCTURE AND OPERATING

4.RELIABILITY

ITEM	TEST CONDITION	ACCEPTANCE CRITERIA
TEMPERATURE UP WITH TYPICAL LOAD	TEST THE SURFACE OF THE CASE WITH TYPICAL LOAD OUTPUT AND TYPICAL AC INPUT 50/60Hz	TEMPERATURE UP UNDER 35 DEGREES
HI-POT TEST	INPUT TO OUTPUT GRADUALLY RAISED FROM 0 TO THE 3000Vac AND HELD AT THAT VALUE FOR 3S,5mA	NO DAMAGE
INSULATION RESISTANCE	INPUT TO OUTPUT,DC 500V	>100MΩ
MTBF	TYPICAL INPUT&FULL LOAD , 25℃	50000 HOURS
LIFE	TYPICAL INPUT&FULL LOAD, 40℃ TYPICAL INPUT&FULL LOAD, 25℃	1YEARS ABOVE 2YEARS ABOVE
BURN-IN	AT 30℃(±10℃),NORMAL INPUT VOLTAGE	2~4 HOURS

5.ENVIRONMENT

ITEM	SPECIFICATION OR TEST CONDITION	min.	typ.	max.
OPERATING TEMPERATURE		0℃		40℃
STORAGE TEMPERATURE		-20℃		85℃
OPERATING HUMIDITY	NON-CONDENSING	5%RH		90%RH
STORAGE HUMIDITY	NON-CONDENSING	5%RH		90%RH

Anthin	DESCRIPTION	SWITCHING POWER	SHEET NO.	4 OF 4
	N	AC ADAPTER	VER:	A1
	MODEL NO.	APL324-1024	PART NO.	ST-0222

6.OUTLOOKING

DIMENSION :96(L)X43.7(W)X27.8(H)mm
 WEIGHT :ABOUT 170g
 AC INPUT TYPE : WALL MOUNT
 DC OUTPUT TYPE :5.5×2.1×9.5MM S TYPE

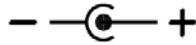

DC OUTPUT CABLE :USE UL SPT-1 18AWG WIRE RoHS COMPLIANT
 INDICATION :LABEL RoHS COMPLIANT
 CASE MATERIAL :94V-0 ABS+PC **BLACK** RoHS COMPLIANT
 PCB MATERIAL :94V-0 RoHS COMPLIANT

7.SAFETY

COMPLY SAFETY STANDARDS	STANDARD	FILE NO.

EMI
CE

8.QC CHECK

ALL OF THE QUANTITY SHALL BE CHECKED BEFORE SHIPMENT,CHECK ITEM AS BELOW:

- (1)DC PLUG POLE CHECK
- (2)OCP FUNCTION CHECK
- (3)DC OUTPUT VOLTAGE CHECK
- (4)HIPOT&INSULATION CHECK
- (5)OUTLOOKING CHECK

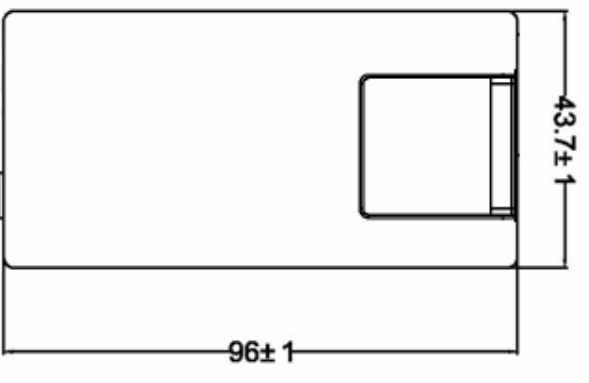
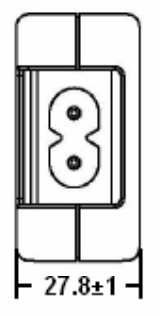
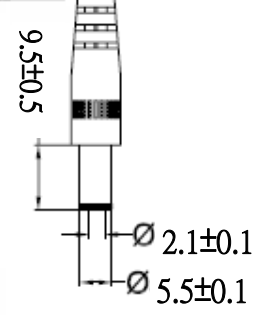
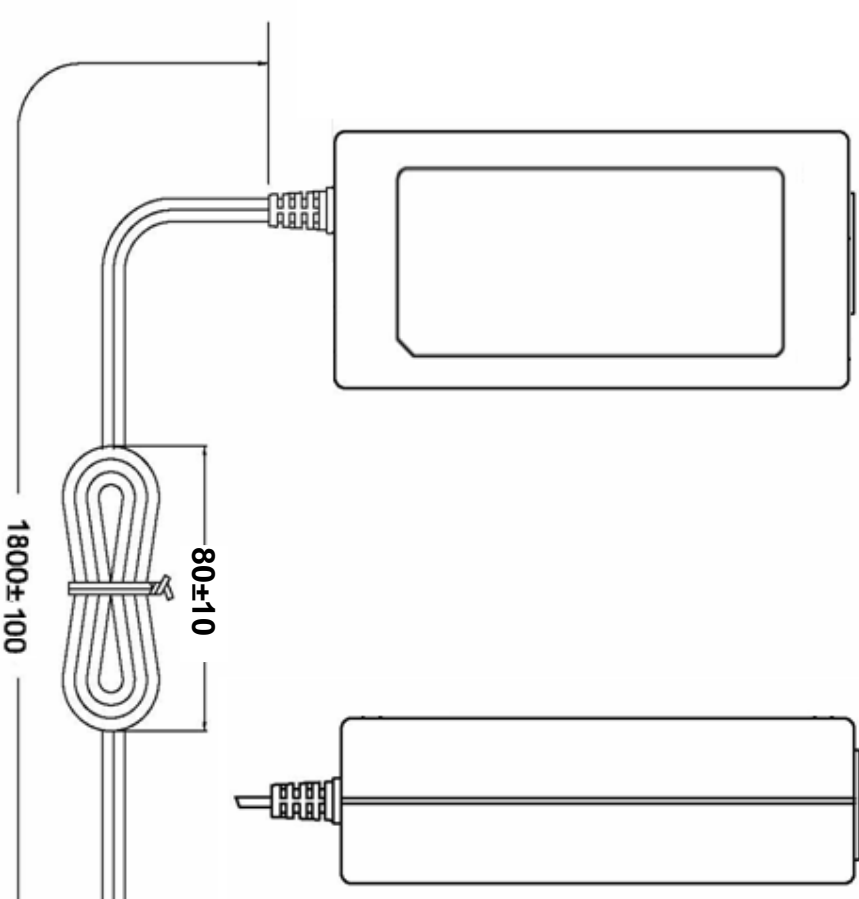

TOLERANCE		FINISH		XXXXXXX	
L&4	+0.06 +0.08 +0.1 +0.2				
4-4.620	+0.06 -0.1 +0.2 +0.3				
20-4.620	+0.1 +0.15 +0.3 +0.4				
60-4.620	+0.15 +0.25 +0.5 +0.8				
200-L	+0.2 +0.4 +0.5 25%				

DRG.	CHGD.	APPR.	SCALE	UNIT	REV.	NAME
				mm	A1	DIMENSION
jmh						
PART NO.						ST-0222

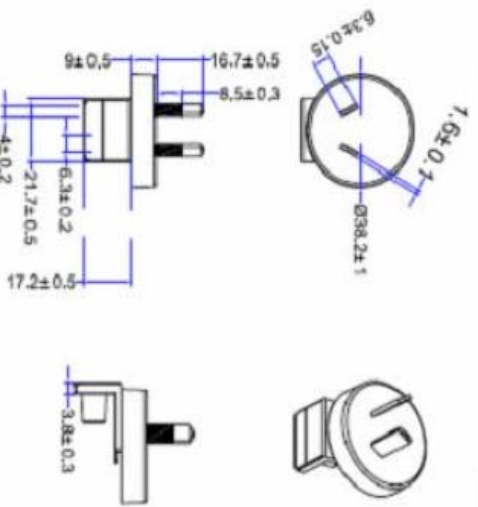
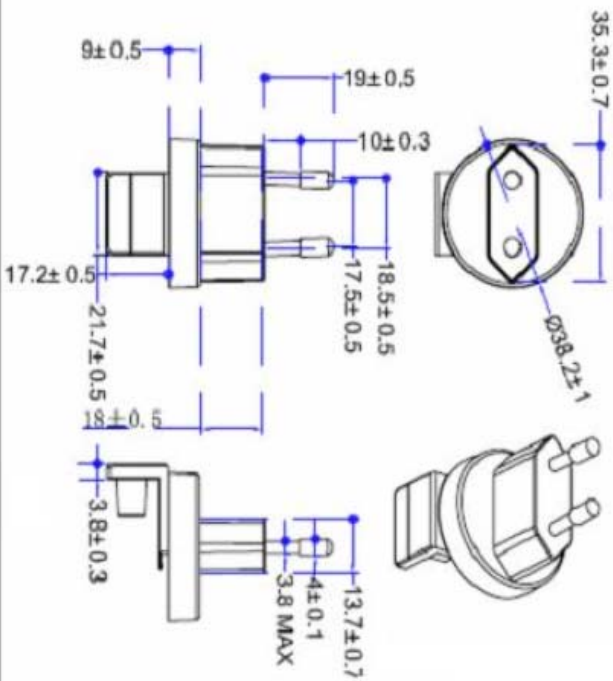
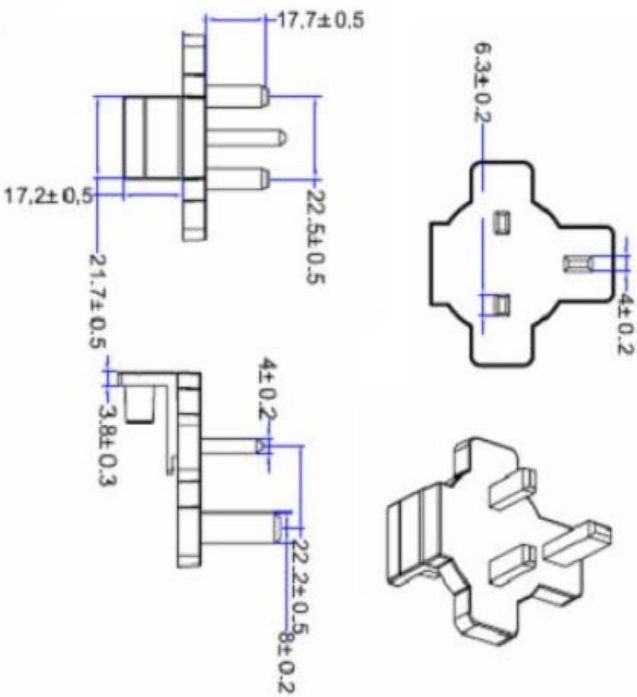
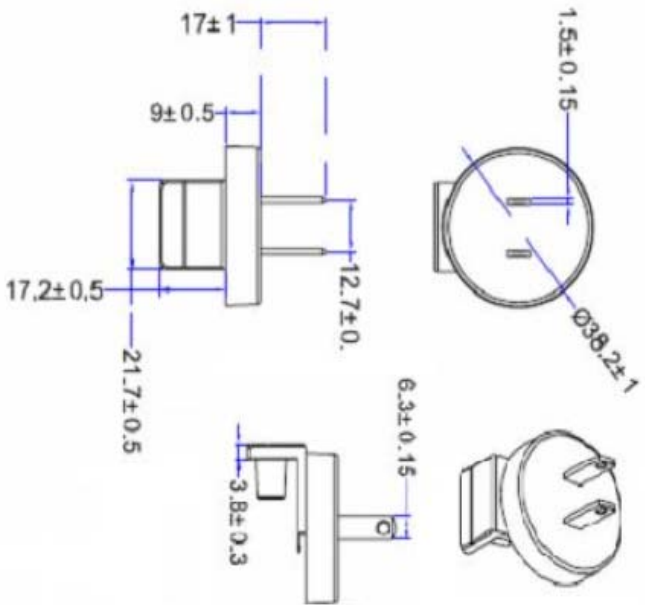

TOLERANCE												
±0.025	±0.050	±0.100	±0.150	±0.200	±0.300	±0.400	±0.500	±0.635	±0.750	±0.875	±1.000	±1.250
±0.0125	±0.025	±0.050	±0.075	±0.100	±0.150	±0.200	±0.250	±0.315	±0.375	±0.438	±0.500	±0.625
±0.00625	±0.0125	±0.025	±0.038	±0.050	±0.075	±0.100	±0.125	±0.158	±0.188	±0.219	±0.250	±0.313
±0.003125	±0.00625	±0.0125	±0.019	±0.025	±0.038	±0.050	±0.063	±0.079	±0.094	±0.109	±0.125	±0.156

FINISH	XXXXXX	MATERIAL	XXX	UNIT	mm	REV.	A1	SCALE	1:1	DATE	XXXX	DRAWN	ML	NAME	ST-0222
DESIGNER		SCALE		DATE		DATE		SCALE		DATE		DATE		DATE	
CHECKER		SCALE		DATE		DATE		SCALE		DATE		DATE		DATE	
APPR.		SCALE		DATE		DATE		SCALE		DATE		DATE		DATE	
DATE		SCALE		DATE		DATE		SCALE		DATE		DATE		DATE	

jmh

ST-0222

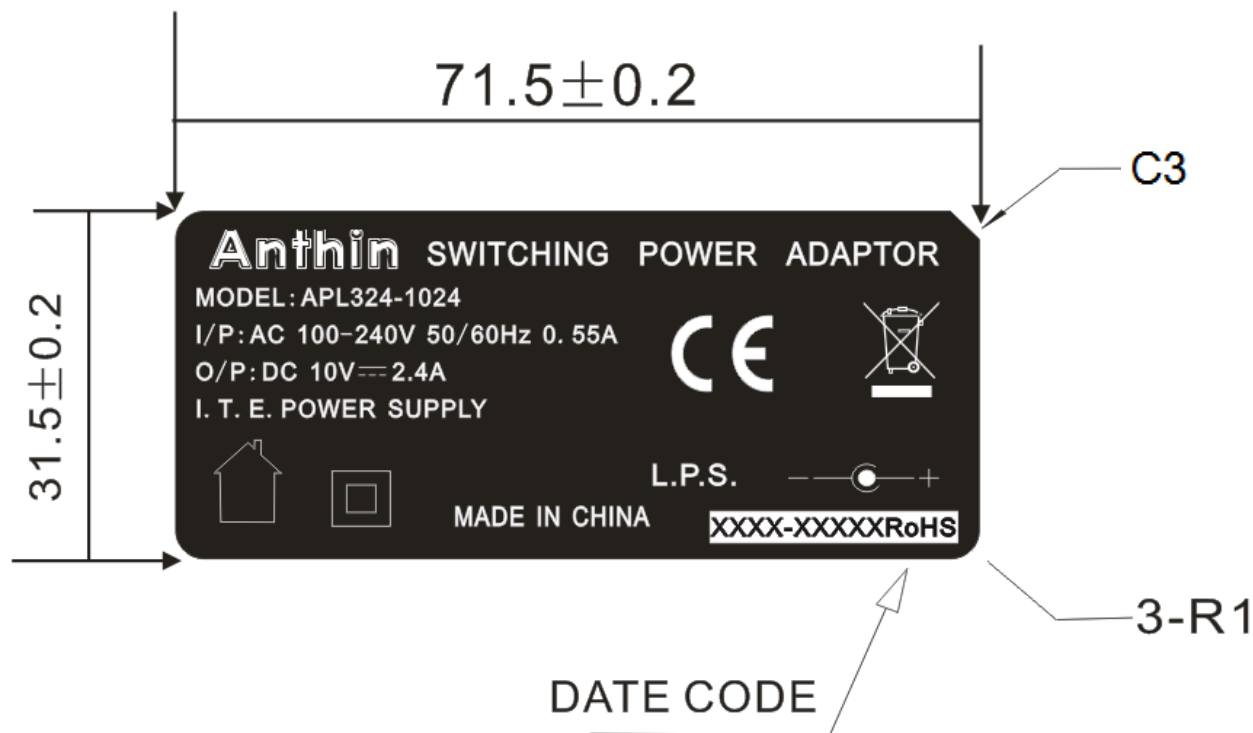

XXXX-XXXXXRoHS

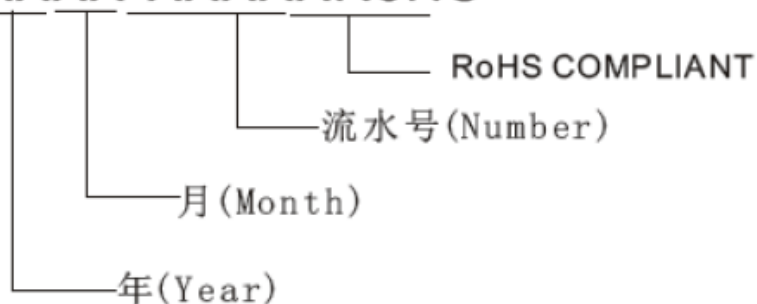

NOTE:

- 1.SILVER WORD(银字) ON BLACK BASE(黑底).
- 2.MATERIAL:PVC + MYLAR FILM
- 3.ROHS COMPLIANT.

TOLERANCE					FINISH	NAME: LABEL	
L < 4	0.05	0.06	0.1	0.2		MATERIAL	QTY
4 < L ≤ 20	0.06	0.4	0.2	0.3	A1		
20 < L ≤ 50	0.1	0.15	0.3	0.4	SCALE	UNIT	PART NO.
50 < L ≤ 200	0.15	0.25	0.4	0.6			
200 < L	0.2	0.4	0.5	0.8	REF.	REM.	
DEG.	CHKD.	APPD.	SCALE		UNIT	mm	REV.
Anni					REF.		
					REM.		

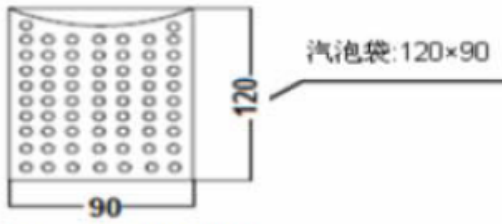

汽泡袋:120×90

注:汽泡袋不用胶纸固定

成品1PCS装入汽泡袋+可换头放入小白盒
 小白盒材质 (450G)
 外径尺寸:长*宽*高
 L*W*H (136*58*77mm)
 TOLERANCE : ±1

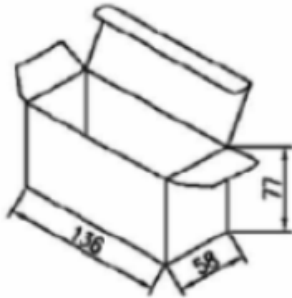

WHITE INNER BOX+OUT CARTON
 WHITE INNER BOX OUT SIDE DIMENSION :
 L*W*H (136*58*77mm)
 TOLERANCE : ±1

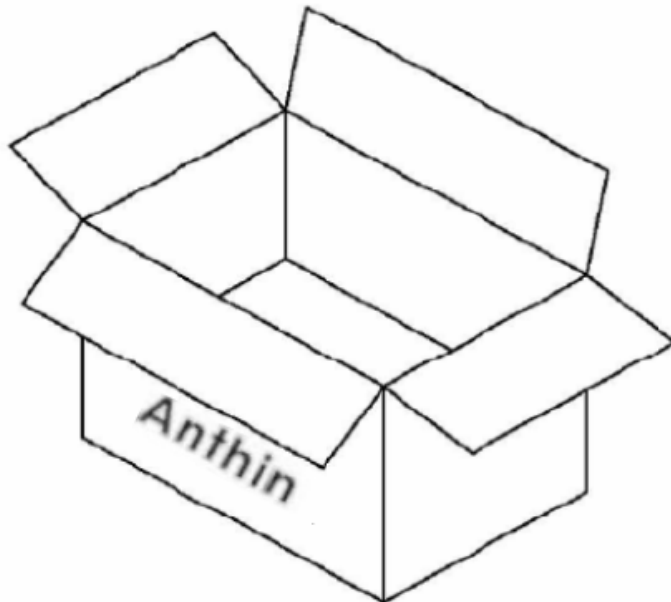
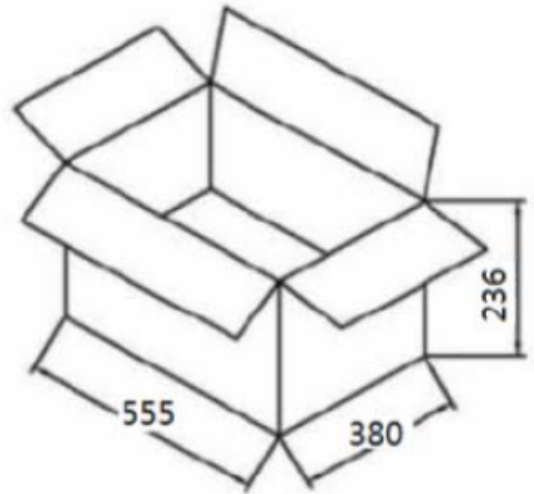
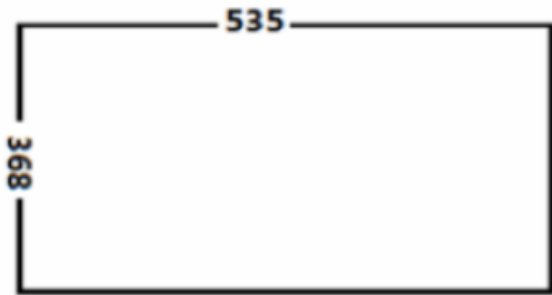

成品67PCS装入外箱
 外箱3段:K=A
 外径尺寸:长*宽*高
 L555*W380*H236mm
 平卡尺寸:长*宽
 L535*W368mm

TOLERANCE					FINISH		
L<4	±0.05	±0.08	±0.1	±0.2			
4<L<20	±0.08	±0.1	±0.2	±0.3			
20<L<50	±0.1	±0.15	±0.3	±0.4			
50<L<200	±0.15	±0.25	±0.4	±0.6	MATERIAL	REV. A1	
200<L	±0.2	±0.4	±0.5	±0.8			
DEG.	CHKD.	APPD.	UNIT	mm	NAME 12.PACKING		
Anni			SCALE	REF.	PART NO. ST-0222		
				DWG NO.			